

Aluminum Electrolytic Capacitors Radial Standard Ultra Miniature

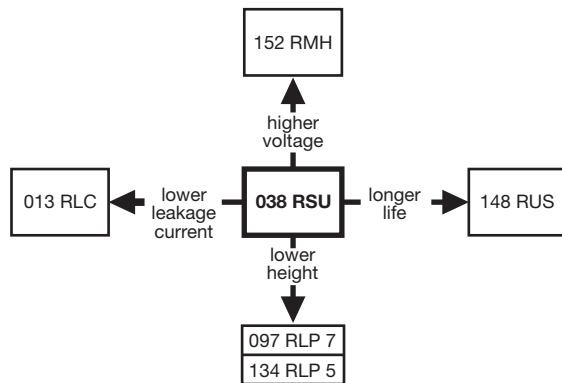
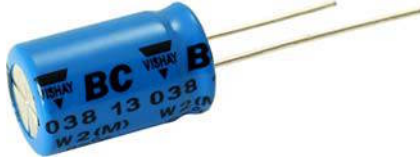

Fig. 1

QUICK REFERENCE DATA	
DESCRIPTION	VALUE
Nominal case sizes ($\varnothing D \times L$ in mm)	5 x 11 to 18 x 40
Rated capacitance range, C_R	2.2 μF to 22 000 μF
Tolerance on C_R	$\pm 20\%$
Rated voltage range, U_R	6.3 V to 100 V
Category temperature range	-40 °C to +85 °C
Endurance test at 85 °C:	
Case size $\varnothing D \leq 8$ mm	2000 h
Case size $\varnothing D \geq 10$ mm	3000 h
Useful life at 85 °C:	
Case size $\varnothing D \leq 8$ mm	2500 h
Case size $\varnothing D \geq 10$ mm	3500 h
Useful life at 40 °C, 1.4 x I_R applied:	
Case size $\varnothing D \leq 8$ mm	60 000 h
Case size $\varnothing D \geq 10$ mm	90 000 h
Shelf life at 0 V, 85 °C	1000 h
Based on sectional specification	IEC 60384-4 / EN130300
Climatic category IEC 60068	40 / 085 / 56

FEATURES

- Polarized aluminum electrolytic capacitors, non-solid electrolyte
- Radial leads, cylindrical aluminum case, insulated with a blue sleeve
- Pressure relief for case $\varnothing D \geq 6.3$ mm
- Charge and discharge proof
- Miniaturized, high CV-product per unit volume
- Material categorization: for definitions of compliance please see www.vishay.com/doc?99912

**RoHS
COMPLIANT**

APPLICATIONS

- General purpose, industrial, automotive, consumer, and audio-video
- Coupling, decoupling, timing, smoothing, filtering, buffering in SMPS
- Portable and mobile equipment (small size, low mass)

MARKING

The capacitors are marked (where possible) with the following information:

- Rated capacitance (in μF)
- Tolerance on rated capacitance, code letter in accordance with IEC 60062 (M for $\pm 20\%$)
- Rated voltage (in V)
- Date code, in accordance with IEC 60062
- Code indicating factory of origin
- Name of manufacturer
- Negative terminal identification
- Series number (038)

SELECTION CHART FOR C_R, U_R, AND RELEVANT NOMINAL CASE SIZES ($\varnothing D \times L$ in mm)								
C_R (μF)	U_R (V)							
	6.3	10	16	25	35	50	63	100
2.2	–	–	–	–	–	–	5 x 11	5 x 11
3.3	–	–	–	–	–	–	5 x 11	5 x 11
4.7	–	–	–	–	–	–	5 x 11	5 x 11
10	–	–	–	–	–	–	5 x 11	6.3 x 11
22	–	–	–	–	–	5 x 11	5 x 11	6.3 x 11
33	–	–	–	–	–	5 x 11	6.3 x 11	8 x 11.5
47	–	–	–	–	5 x 11	6.3 x 11	6.3 x 11	10 x 12
100	–	5 x 11	5 x 11	6.3 x 11	6.3 x 11	8 x 11.5	10 x 12	10 x 20
220	5 x 11	5 x 11	6.3 x 11	8 x 11.5	8 x 11.5	10 x 12	10 x 16	13 x 25
330	6.3 x 11	6.3 x 11	8 x 11.5	8 x 11.5	10 x 12	10 x 16	10 x 20	13 x 25
470	6.3 x 11	6.3 x 11	8 x 11.5	10 x 12	10 x 16	10 x 20	13 x 20	16 x 25
1000	8 x 11.5	10 x 12	10 x 16	10 x 20	13 x 20	13 x 25	16 x 25	18 x 40
2200	10 x 16	10 x 20	13 x 20	13 x 25	6 x 25	16 x 31	18 x 35	–
3300	10 x 20	13 x 20	13 x 25	16 x 25	16 x 35	18 x 35	–	–
4700	13 x 20	13 x 25	16 x 25	16 x 31	18 x 35	–	–	–
6800	13 x 25	16 x 25	16 x 31	18 x 35	–	–	–	–
10 000	16 x 25	16 x 35	18 x 35	–	–	–	–	–
22 000	18 x 40	–	–	–	–	–	–	–

DIMENSIONS in millimeters AND AVAILABLE FORMS

Fig. 2 - Form CA

 Fig. 3 - Form CB:
Cut leads

Dimensions of pitch F see Table 1 and Table 2

 Fig. 4 - Form TNA, Form TFA:
Taped in box (ammopack), straight leads

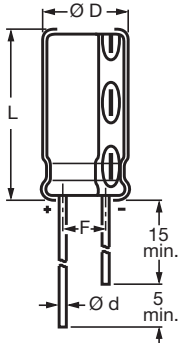
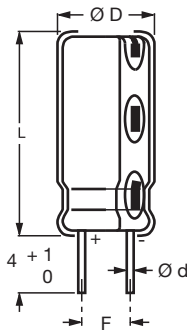
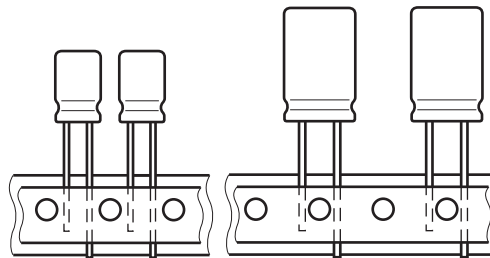
 Case $\varnothing D = 5$ mm to 8 mm; pitch F is 5 mm

 Fig. 5 - Form TFA:
Taped in box (ammopack), formed leads

Table 1

DIMENSIONS in millimeters, MASS AND PACKAGING QUANTITIES									
NOMINAL CASE SIZE $\varnothing D \times L$	CASE CODE	$\varnothing d$	$\varnothing D_{max.}$	$L_{max.}$	F	MASS (g)	PACKAGING QUANTITIES		
							FORM CA	FORM CB	FORM TFA, TNA
5 x 11	11	0.5	5.5	12.5	2.0 ± 0.5	≈ 0.4	5000	–	2000
6.3 x 11	12	0.5	6.8	12.5	2.5 ± 0.5	≈ 0.6	5000	–	2000
8 x 11.5	13	0.6	8.5	12.5	3.5 ± 0.5	≈ 1.1	5000	–	1000
10 x 12	14	0.6	10.5	13.5	5.0 ± 0.5	≈ 1.6	3000	1000	500
10 x 16	15	0.6	10.5	17.5	5.0 ± 0.5	≈ 1.9	2500	1000	500
10 x 20	16	0.6	10.5	22.0	5.0 ± 0.5	≈ 2.2	2000	800	500
13 x 20	17	0.6	13.5	22.0	5.0 ± 0.5	≈ 4.0	1500	400	300
13 x 25	18	0.6	13.5	27.0	5.0 ± 0.5	≈ 5.0	1000	400	300
16 x 25	19	0.8	16.5	27.0	7.5 ± 0.5	≈ 8.0	750	200	200
16 x 31	20	0.8	16.5	33.5	7.5 ± 0.5	≈ 9.0	600	200	200
16 x 35	21	0.8	16.5	37.5	7.5 ± 0.5	≈ 11.0	500	200	–
18 x 35	22	0.8	18.5	37.5	7.5 ± 0.5	≈ 14.5	400	150	–
18 x 40	23	0.8	18.5	42.0	7.5 ± 0.5	≈ 16.0	400	150	–

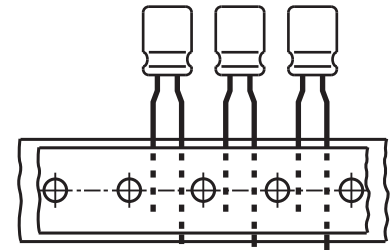
Note

- Detailed tape dimensions see section "Packaging".



ELECTRICAL DATA	
SYMBOL	DESCRIPTION
C_R	Rated capacitance at 100 Hz, tolerance $\pm 20\%$
I_R	Rated RMS ripple current at 100 Hz, 85 °C
I_{L2}	Max. leakage current after 2 min at U_R
$\tan \delta$	Max. dissipation factor at 100 Hz

ORDERING EXAMPLE

Electrolytic capacitor 038 series

470 μF / 25 V; $\pm 20\%$

Nominal case size: \varnothing 10 mm x 12 mm; form TFA

Ordering code: MAL2 038 36471 E3

Former 12NC: 2222 038 36471

Note

- Unless otherwise specified, all electrical values in Table 2 apply at $T_{amb} = 20\text{ °C}$, $P = 86\text{ kPa}$ to 106 kPa , $RH = 45\%$ to 75% .

Table 2

ELECTRICAL DATA AND ORDERING INFORMATION														
U_R (V)	C_R 100 Hz (μF)	NOMINAL CASE SIZE $\varnothing D \times L$ (mm)	I_R 100 Hz 85 °C (mA)	I_{L2} 2 min (μA)	$\tan \delta$ 100 Hz	FREQ. CODE ⁽¹⁾	ORDERING CODE MAL2038							
							BULK PACKAGING				TAPED AMMOPACK			
							LONG LEADS		CUT LEADS		FORM TFA		FORM TNA	
							FORM CA	F (mm)	FORM CB	F (mm)	FORM TFA	F (mm)	FORM TNA	F (mm)
6.3	220	5 x 11	200	14	0.23	MF2	53221E3	2.0	-	-	33221E3	5.0	73221E3	2.5
	330	6.3 x 11	270	21	0.23	MF2	53331E3	2.5	-	-	33331E3	5.0	73331E3	2.5
	470	6.3 x 11	320	30	0.23	MF2	53471E3	2.5	-	-	33471E3	5.0	73471E3	2.5
	1000	8 x 11.5	540	63	0.23	MF2	53102E3	3.5	-	-	33102E3	5.0	73102E3	3.5
	2200	10 x 16	785	139	0.25	MF3	53222E3	5.0	63222E3	5.0	33222E3	5.0	-	-
	3300	10 x 20	1185	208	0.27	MF3	53332E3	5.0	63332E3	5.0	33332E3	5.0	-	-
	4700	13 x 20	1545	296	0.29	MF3	53472E3	5.0	63472E3	5.0	33472E3	5.0	-	-
	6800	13 x 25	1880	428	0.33	MF3	53682E3	5.0	63682E3	5.0	33682E3	5.0	-	-
	10 000	16 x 25	2330	630	0.41	MF3	53103E3	7.5	63103E3	7.5	33103E3	7.5	-	-
	22 000	18 x 40	3320	1386	0.65	MF3	53223E3	7.5	63223E3	7.5	-	-	-	-
10	100	5 x 11	145	10	0.20	MF2	54101E3	2.0	-	-	34101E3	5.0	74101E3	2.5
	220	5 x 11	160	22	0.20	MF2	54221E3	2.0	-	-	34221E3	5.0	74221E3	2.5
	330	6.3 x 11	290	33	0.20	MF2	54331E3	2.5	-	-	34331E3	5.0	74331E3	2.5
	470	6.3 x 11	350	47	0.20	MF2	54471E3	2.5	-	-	34471E3	5.0	74471E3	2.5
	1000	10 x 12	650	100	0.20	MF2	54102E3	5.0	64102E3	5.0	34102E3	5.0	-	-
	2200	10 x 20	1070	220	0.22	MF3	54222E3	5.0	64222E3	5.0	34222E3	5.0	-	-
	3300	13 x 20	1420	330	0.24	MF3	54332E3	5.0	64332E3	5.0	34332E3	5.0	-	-
	4700	13 x 25	1780	470	0.26	MF3	54472E3	5.0	64472E3	5.0	34472E3	5.0	-	-
	6800	16 x 25	2220	680	0.30	MF3	54682E3	7.5	64682E3	7.5	34682E3	7.5	-	-
	10 000	16 x 35	2760	1000	0.38	MF3	54103E3	7.5	64103E3	7.5	-	-	-	-
16	100	5 x 11	160	16	0.16	MF2	55101E3	2.0	-	-	35101E3	5.0	75101E3	2.5
	220	6.3 x 11	260	35	0.16	MF2	55221E3	2.5	-	-	35221E3	5.0	75221E3	2.5
	330	8 x 11.5	370	53	0.16	MF2	55331E3	3.5	-	-	35331E3	5.0	75331E3	3.5
	470	8 x 11.5	440	75	0.16	MF2	55471E3	3.5	-	-	35471E3	5.0	75471E3	3.5
	1000	10 x 16	785	160	0.16	MF2	55102E3	5.0	65102E3	5.0	35102E3	5.0	-	-
	2200	13 x 20	1295	352	0.18	MF3	55222E3	5.0	65222E3	5.0	35222E3	5.0	-	-
	3300	13 x 25	1655	528	0.20	MF3	55332E3	5.0	65332E3	5.0	35332E3	5.0	-	-
	4700	16 x 25	2090	752	0.22	MF3	55472E3	7.5	65472E3	7.5	35472E3	7.5	-	-
	6800	16 x 31	2520	1088	0.26	MF3	55682E3	7.5	65682E3	7.5	35682E3	7.5	-	-
	10 000	18 x 35	2920	1600	0.34	MF3	55103E3	7.5	65103E3	7.5	-	-	-	-



ELECTRICAL DATA AND ORDERING INFORMATION														
U _R (V)	C _R 100 Hz (μF)	NOMINAL CASE SIZE Ø D x L (mm)	I _R 100 Hz 85 °C (mA)	I _{L2} 2 min (μA)	tan δ 100 Hz	FREQ. CODE (1)	ORDERING CODE MAL2038							
							BULK PACKAGING				TAPED AMMOPACK			
							LONG LEADS		CUT LEADS		FORM TFA	F (mm)	FORM TNA	F (mm)
							FORM CA	F (mm)	FORM CB	F (mm)				
25	100	6.3 x 11	190	25	0.14	MF2	56101E3	2.5	-	-	36101E3	5.0	76101E3	2.5
	220	8 x 11.5	320	55	0.14	MF2	56221E3	3.5	-	-	36221E3	5.0	76221E3	3.5
	330	8 x 11.5	440	83	0.14	MF2	56331E3	3.5	-	-	36331E3	5.0	76331E3	3.5
	470	10 x 12	545	118	0.14	MF2	56471E3	5.0	66471E3	5.0	36471E3	5.0	-	-
	1000	10 x 20	955	250	0.14	MF2	56102E3	5.0	66102E3	5.0	36102E3	5.0	-	-
	2200	13 x 25	1540	550	0.16	MF3	56222E3	5.0	66222E3	5.0	36222E3	5.0	-	-
	3300	16 x 25	1975	825	0.18	MF3	56332E3	7.5	66332E3	7.5	36332E3	7.5	-	-
	4700	16 x 31	2420	1175	0.20	MF3	56472E3	7.5	66472E3	7.5	36472E3	7.5	-	-
	6800	18 x 35	2880	1700	0.24	MF3	56682E3	7.5	66682E3	7.5	-	-	-	-
35	47	5 x 11	130	17	0.12	MF1	50479E3	2.0	-	-	30479E3	5.0	70479E3	2.5
	100	6.3 x 11	210	35	0.12	MF2	50101E3	2.5	-	-	30101E3	5.0	70101E3	2.5
	220	8 x 11.5	385	77	0.12	MF2	50221E3	3.5	-	-	30221E3	5.0	70221E3	3.5
	330	10 x 12	490	116	0.12	MF2	50331E3	5.0	60331E3	5.0	30331E3	5.0	-	-
	470	10 x 16	740	165	0.12	MF2	50471E3	5.0	60471E3	5.0	30471E3	5.0	-	-
	1000	13 x 20	1145	350	0.12	MF2	50102E3	5.0	60102E3	5.0	30102E3	5.0	-	-
	2200	16 x 25	1785	770	0.14	MF3	50222E3	7.5	60222E3	7.5	30222E3	7.5	-	-
	3300	16 x 35	2275	1155	0.16	MF3	50332E3	7.5	60332E3	7.5	-	-	-	-
	4700	18 x 35	2700	1645	0.18	MF3	50472E3	7.5	60472E3	7.5	-	-	-	-
50	22	5 x 11	95	11	0.10	MF1	51229E3	2.0	-	-	31229E3	5.0	71229E3	2.5
	33	5 x 11	125	17	0.10	MF1	51339E3	2.0	-	-	31339E3	5.0	71339E3	2.5
	47	6.3 x 11	165	24	0.10	MF1	51479E3	2.5	-	-	31479E3	5.0	71479E3	2.5
	100	8 x 11.5	260	50	0.10	MF2	51101E3	3.5	-	-	31101E3	5.0	71101E3	3.5
	220	10 x 12	455	110	0.10	MF2	51221E3	5.0	61221E3	5.0	31221E3	5.0	-	-
	330	10 x 16	585	165	0.10	MF2	51331E3	5.0	61331E3	5.0	31331E3	5.0	-	-
	470	10 x 20	755	235	0.10	MF2	51471E3	5.0	61471E3	5.0	31471E3	5.0	-	-
	1000	13 x 25	1340	500	0.10	MF2	51102E3	5.0	61102E3	5.0	31102E3	5.0	-	-
	2200	16 x 31	1885	1100	0.12	MF3	51222E3	7.5	61222E3	7.5	31222E3	7.5	-	-
3300	18 x 35	2500	1650	0.14	MF3	51332E3	7.5	61332E3	7.5	-	-	-	-	
63	2.2	5 x 11	28	3.0	0.09	MF1	58228E3	2.0	-	-	38228E3	5.0	78228E3	2.5
	3.3	5 x 11	34	3.0	0.09	MF1	58338E3	2.0	-	-	38338E3	5.0	78338E3	2.5
	4.7	5 x 11	45	3.0	0.09	MF1	58478E3	2.0	-	-	38478E3	5.0	78478E3	2.5
	10	5 x 11	70	6.3	0.09	MF1	58109E3	2.0	-	-	38109E3	5.0	78109E3	2.5
	22	5 x 11	105	14	0.09	MF1	58229E3	2.0	-	-	38229E3	5.0	78229E3	2.5
	33	6.3 x 11	140	21	0.09	MF1	58339E3	2.5	-	-	38339E3	5.0	78339E3	2.5
	47	6.3 x 11	170	30	0.09	MF1	58479E3	2.5	-	-	38479E3	5.0	78479E3	2.5
	100	10 x 12	320	63	0.09	MF2	58101E3	5.0	68101E3	5.0	38101E3	5.0	-	-
	220	10 x 16	490	139	0.09	MF2	58221E3	5.0	68221E3	5.0	38221E3	5.0	-	-
	330	10 x 20	710	208	0.09	MF2	58331E3	5.0	68331E3	5.0	38331E3	5.0	-	-
	470	13 x 20	900	296	0.09	MF2	58471E3	5.0	68471E3	5.0	38471E3	5.0	-	-
	1000	16 x 25	1560	630	0.09	MF2	58102E3	7.5	68102E3	7.5	38102E3	7.5	-	-
2200	18 x 35	1950	1386	0.11	MF3	58222E3	7.5	68222E3	7.5	-	-	-	-	



ELECTRICAL DATA AND ORDERING INFORMATION														
U _R (V)	C _R 100 Hz (μF)	NOMINAL CASE SIZE Ø D x L (mm)	I _R 100 Hz 85 °C (mA)	I _{L2} 2 min (μA)	tan δ 100 Hz	FREQ. CODE ⁽¹⁾	ORDERING CODE MAL2038							
							BULK PACKAGING				TAPED AMMOPACK			
							LONG LEADS		CUT LEADS		FORM TFA	F (mm)	FORM TNA	F (mm)
							FORM CA	F (mm)	FORM CB	F (mm)				
100	2.2	5 x 11	33	3.0	0.08	MF1	59228E3	2.0	-	-	39228E3	5.0	79228E3	2.5
	3.3	5 x 11	40	3.3	0.08	MF1	59338E3	2.0	-	-	39338E3	5.0	79338E3	2.5
	4.7	5 x 11	48	4.7	0.08	MF1	59478E3	2.0	-	-	39478E3	5.0	79478E3	2.5
	10	6.3 x 11	80	10	0.08	MF1	59109E3	2.5	-	-	39109E3	5.0	79109E3	2.5
	22	6.3 x 11	115	22	0.08	MF1	59229E3	2.5	-	-	39229E3	5.0	79229E3	2.5
	33	8 x 11.5	145	33	0.08	MF1	59339E3	3.5	-	-	39339E3	5.0	79339E3	3.5
	47	10 x 12	235	47	0.08	MF1	59479E3	5.0	69479E3	5.0	39479E3	5.0	-	-
	100	10 x 20	370	100	0.08	MF2	59101E3	5.0	69101E3	5.0	39101E3	5.0	-	-
	220	13 x 25	675	220	0.08	MF2	59221E3	5.0	69221E3	5.0	39221E3	5.0	-	-
	330	13 x 25	825	330	0.08	MF2	59331E3	5.0	69331E3	5.0	39331E3	5.0	-	-
	470	16 x 25	1070	470	0.08	MF2	59471E3	7.5	69471E3	7.5	39471E3	7.5	-	-
	1000	18 x 40	2410	1000	0.08	MF2	59102E3	7.5	69102E3	7.5	-	-	-	-

Note

⁽¹⁾ Determines the applicable row in the table “Multiplier of Ripple Current (I_R) as a Function of Frequency”

ADDITIONAL ELECTRICAL DATA		
PARAMETER	CONDITIONS	VALUE
Voltage		
Surge voltage		U _S ≤ 1.15 x U _R
Reverse voltage		U _{REV} ≤ 1 V
Current		
Leakage current	After 2 min at U _R	I _{L2} ≤ 0.01 C _R x U _R or 3 μA, whichever is greater
	After 5 min at U _R	I _{L5} ≤ 0.002 C _R x U _R + 3 μA
Inductance		
Equivalent series inductance (ESL)	Case Ø D ≤ 8 mm	Typ. 13 nH
	Case Ø D = 10 mm	Typ. 16 nH
	Case Ø D ≥ 12.5 mm	Typ. 18 nH
Resistance		
Equivalent series resistance (ESR)	Calculated from tan δ _{max} and C _R (see Table 2)	ESR = tan δ/2 π f C _R

CAPACITANCE (C)

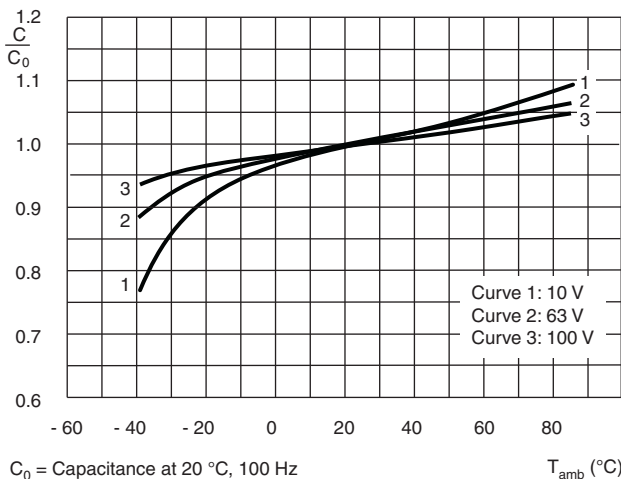

Fig. 6 - Typical multiplier of capacitance as a function of ambient temperature

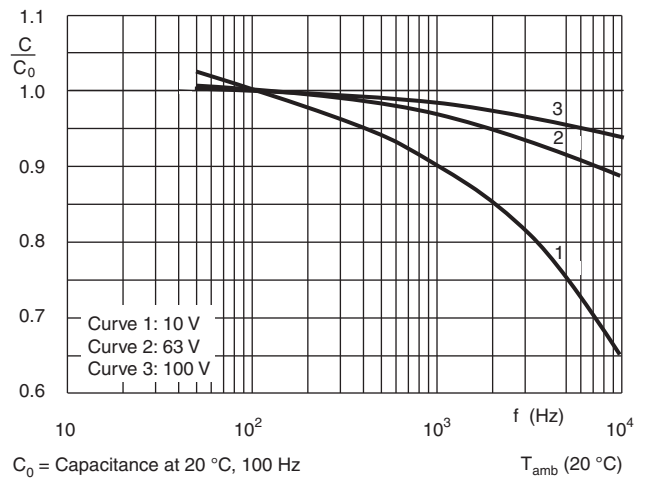

Fig. 7 - Typical multiplier of capacitance as a function of frequency

RIPPLE CURRENT AND USEFUL LIFE

Table 3

ENDURANCE TEST DURATION AND USEFUL LIFE		
NOMINAL CASE SIZE Ø D x L (mm)	ENDURANCE AT 85 °C (h)	USEFUL LIFE AT 85 °C (h)
5 x 11	2000	2500
6.3 x 11	2000	2500
8 x 11.5	2000	2500
10 x 12	3000	3500
10 x 16	3000	3500
10 x 20	3000	3500
13 x 20	3000	3500
13 x 25	3000	3500
16 x 25	3000	3500
16 x 31	3000	3500
16 x 35	3000	3500
18 x 35	3000	3500
18 x 40	3000	3500

Note

- Multiplier of useful life code: CCC205

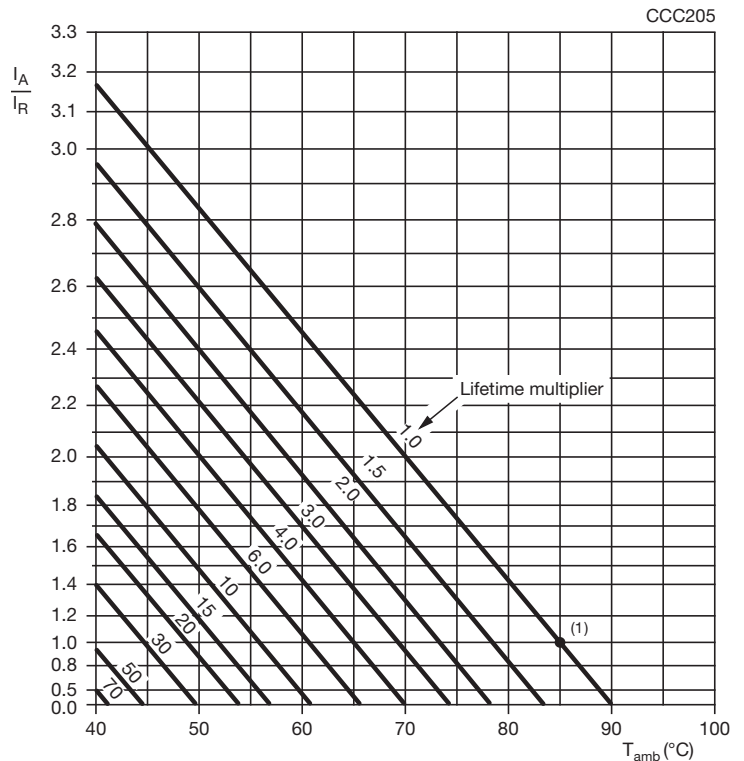

I_A = Actual ripple current at 100 Hz
 I_R = Rated ripple current at 100 Hz, 85 °C
 Useful life at 85 °C and I_R applied:
 Case $\varnothing D \leq 8$ mm: 2500 h
 Case $\varnothing D \geq 10$ mm: 3500 h

Fig. 8 - Multiplier of useful life as a function of ambient temperature and ripple current load

Table 4

MULTIPLIER OF RIPPLE CURRENT (I_R) AS A FUNCTION OF FREQUENCY					
FREQ. CODE	FREQUENCY (Hz)				
	50	100	500	1000	≥ 10 000
	I_R MULTIPLIER				
MF1	0.70	1.00	1.30	1.40	1.50
MF2	0.75	1.00	1.20	1.30	1.35
MF3	0.80	1.00	1.10	1.12	1.15

Table 5

TEST PROCEDURES AND REQUIREMENTS			
TEST		PROCEDURE (quick reference)	REQUIREMENTS
NAME OF TEST	REFERENCE		
Endurance	IEC 60384-4 / EN 130300 subclause 4.13	$T_{amb} = 85\text{ °C}$; U_R applied; Case $\varnothing \leq 8\text{ mm}$: 2000 h Case $\varnothing \geq 10\text{ mm}$: 3000 h	$\Delta C/C: \pm 20\%$ $\tan \delta \leq 2 \times \text{spec. limit}$ $I_{L5} \leq \text{spec. limit}$
Useful life	CECC 30301 subclause 1.8.1	$T_{amb} = 85\text{ °C}$; U_R and I_R applied; Case $\varnothing \leq 8\text{ mm}$: 2500 h Case $\varnothing \geq 10\text{ mm}$: 3500 h	$\Delta C/C: \pm 50\%$ $\tan \delta \leq 3 \times \text{spec. limit}$ $I_{L5} \leq \text{spec. limit}$ no short or open circuit total failure percentage: $\leq 1\%$
Shelf life (storage at high temperature)	IEC 60384-4 / EN 130300 subclause 4.17	$T_{amb} = 85\text{ °C}$; no voltage applied; 1000 h after test: U_R to be applied for 30 min, 24 h to 48 h before measurement	$\Delta C/C: \pm 20\%$ $\tan \delta \leq 2 \times \text{spec. limit}$ $I_{L5} \leq 3 \times \text{spec. limit}$
Surge	IEC 60384-4 / EN 130300 subclause 4.14	From source of $1.15 \times U_R$; $RC = 0.1\text{ s} \pm 0.05\text{ s}$; 1000 cycles of 30 s on, 330 s off, at 85 °C	$\Delta C/C: \pm 25\%$ $\tan \delta \leq 1.5 \times \text{spec. limit}$ $I_{L5} \leq \text{spec. limit}$

Statements about product lifetime are based on calculations and internal testing. They should only be interpreted as estimations. Also due to external factors, the lifetime in the field application may deviate from the calculated lifetime. In general, nothing stated herein shall be construed as a guarantee of durability.



Disclaimer

ALL PRODUCT, PRODUCT SPECIFICATIONS AND DATA ARE SUBJECT TO CHANGE WITHOUT NOTICE TO IMPROVE RELIABILITY, FUNCTION OR DESIGN OR OTHERWISE.

Vishay Intertechnology, Inc., its affiliates, agents, and employees, and all persons acting on its or their behalf (collectively, "Vishay"), disclaim any and all liability for any errors, inaccuracies or incompleteness contained in any datasheet or in any other disclosure relating to any product.

Vishay makes no warranty, representation or guarantee regarding the suitability of the products for any particular purpose or the continuing production of any product. To the maximum extent permitted by applicable law, Vishay disclaims (i) any and all liability arising out of the application or use of any product, (ii) any and all liability, including without limitation special, consequential or incidental damages, and (iii) any and all implied warranties, including warranties of fitness for particular purpose, non-infringement and merchantability.

Statements regarding the suitability of products for certain types of applications are based on Vishay's knowledge of typical requirements that are often placed on Vishay products in generic applications. Such statements are not binding statements about the suitability of products for a particular application. It is the customer's responsibility to validate that a particular product with the properties described in the product specification is suitable for use in a particular application. Parameters provided in datasheets and / or specifications may vary in different applications and performance may vary over time. All operating parameters, including typical parameters, must be validated for each customer application by the customer's technical experts. Product specifications do not expand or otherwise modify Vishay's terms and conditions of purchase, including but not limited to the warranty expressed therein.

Except as expressly indicated in writing, Vishay products are not designed for use in medical, life-saving, or life-sustaining applications or for any other application in which the failure of the Vishay product could result in personal injury or death. Customers using or selling Vishay products not expressly indicated for use in such applications do so at their own risk. Please contact authorized Vishay personnel to obtain written terms and conditions regarding products designed for such applications.

No license, express or implied, by estoppel or otherwise, to any intellectual property rights is granted by this document or by any conduct of Vishay. Product names and markings noted herein may be trademarks of their respective owners.